

GW90 & ONYX GW90 Shower Waste

INSTALLATION INSTRUCTIONS



GW90 - 25120



ONYX GW90- 25494



Read all instructions before installation and leave this document with the end user for future reference as it contains important warranty information

Installation Instructions

Contents

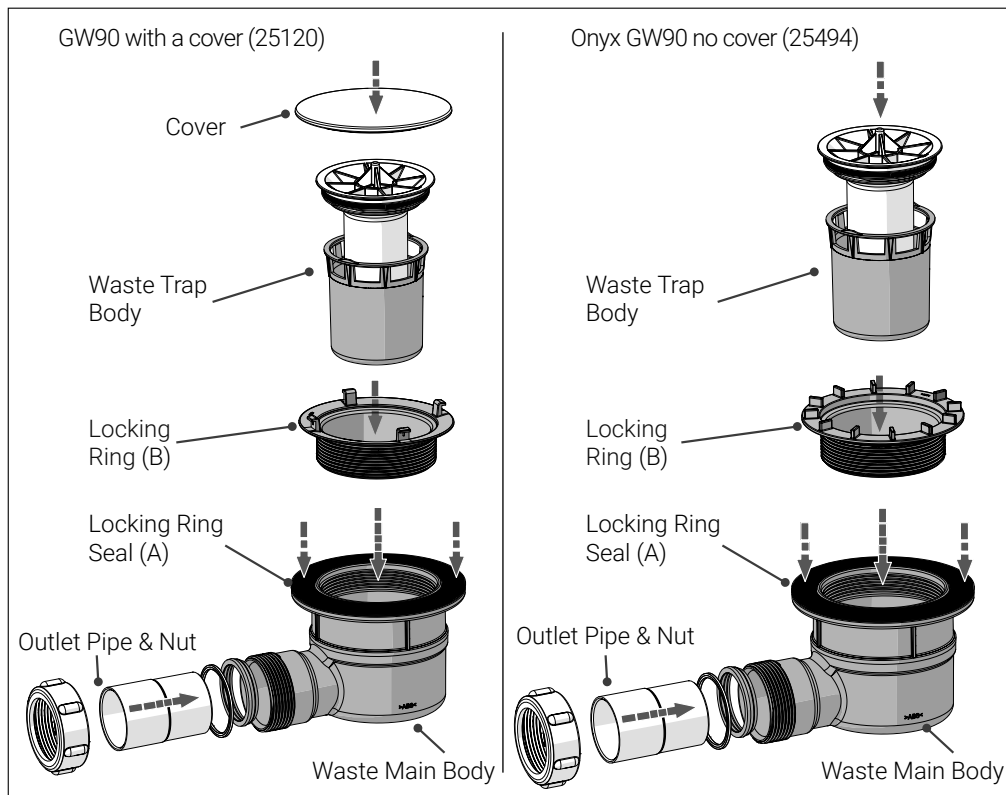

AKW wastes are designed for low maintenance and reliable operation. The trap valve is located inside the waste body should be checked as part of a planned maintenance programme.

Keeping your wastes clean

This product should be cleaned periodically to remove any accumulation of hair or other waste material, using normal domestic bathroom cleaning materials. To clean the waste trap, first remove the cover to gain access.

Disinfecting

Where disinfecting is necessary, standard procedures for disinfecting equipment should be used, taking due care and attention to the warning signs concerning possible effects of aggressive chemicals on plastics. After cleaning, always flush down with water then wipe thoroughly with a damp cloth to remove any cleaning material residues before drying. Do not use strong or concentrated acidic, alkaline or other cleaning materials as these may discolour or otherwise damage the product. Do not use abrasive cloths.

Suitable for wooden and solid floor installations. Use these in accordance with the shower tray instructions.

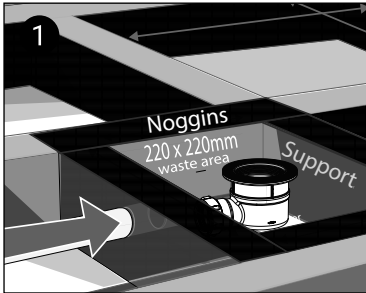

(1) As a "dry run", first place the tray into the desired location either into wooden or solid floors. Determine the position, the depth and the clearance required for the waste with at least a 1 in 40 fall from the waste to the outlet pipe. Ensure there is sufficient support around the waste area, see separate tray instructions.

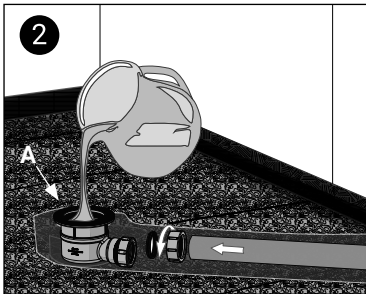

(2) Before fitting the waste, place the nut onto the waste pipe outlet, followed by the backing ring and the seal. Insert waste pipe into the waste body and tighten the nut. Check that the pipe connection is correctly assembled, sealed and watertight by pouring some water through it. Ensure that the rubber clamping seal **(A)** is positioned into the recessed section on the top of the waste body before connecting to the tray.

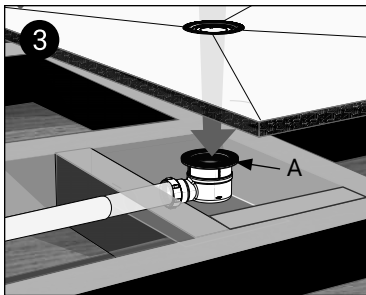

(3-4) Apply flexible adhesive to the tray and ensure that the tray is level. Lower the tray into position either into or onto wooden or concrete floors and then re-align with the waste body.

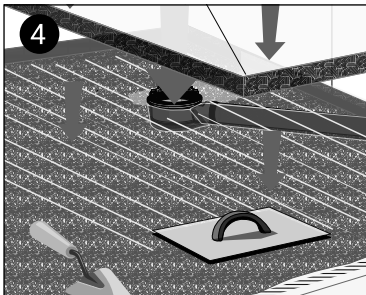

(5-6) Ensure the clamping ring **(B)** is screwed correctly to the waste body and is aligned with the tray. Do not over tighten but ensure a tight seal.

(7) Lower the waste trap body into waste main body and ensure a tight seal is achieved.

(8) Fit the cover ensuring correct location and it is flush with the tray. Protect the trap from debris during installation.

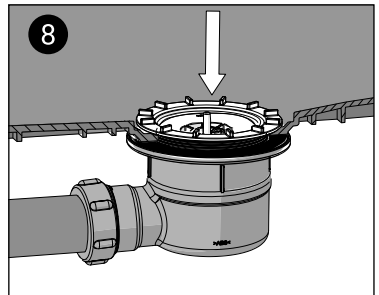
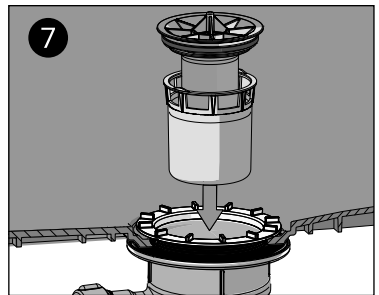
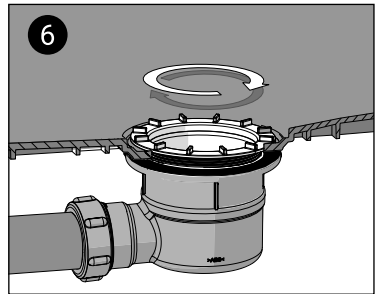
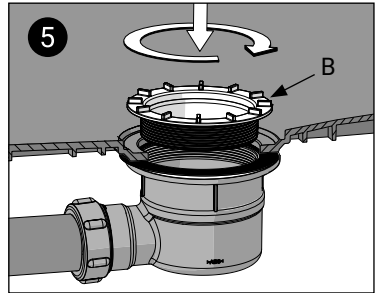

Contact Us

AKW[®]
Life Made Better

Orders & Quotes

01905 823 299
orders@akw-ltd.co.uk

General Enquiries

01905 823 298
sales@akw-ltd.co.uk

Technical Enquiries

01905 560 219
technicalenquiries@akw-ltd.co.uk

Kitchen Enquiries

01905 823 262
kitchens@akw-ltd.co.uk

Fax

01905 823 297

AKW

Pointon Way, Hampton Lovett
Droitwich Spa, WR9 0LR

www.akw-ltd.co.uk
orders.akw-ltd.co.uk



Guarantee

The guarantee only applies to manufacturing or material defects, conditional on the one-time correct installation of the product.

Does not apply to:

- Breakages, inappropriate use or accidental damage.
- Damage or defects that result from incorrect installation.
- Damage caused by lack of maintenance including the build up of grime or damage resulting from inappropriate cleaning.
- Damage or defects that result from repairs or modifications undertaken by unauthorised persons.
- This guarantee excludes general wear and tear through usage and does not apply to surface finishes.

What to do if something goes wrong?

If you should encounter a problem with this product, please contact your local installer and if this does not resolve the issue, then contact AKW Technical Enquiries who will provide further advice and, if necessary, arrange for a maintenance engineer to visit and report any issues. See the T&Cs on our website or our catalogue for further information. None of the foregoing affects your statutory rights.