

90mm Dia. Low Depth Waste

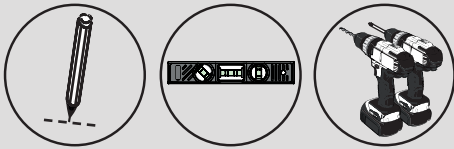

Installation Instructions
& User Care Instructions



Installer- please read all instructions carefully before installation
and leave these instructions with the end user for future reference

Installation Instructions

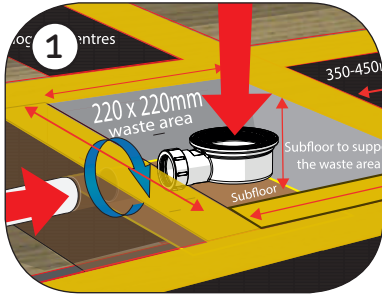

(1) As a “dry run”, first place the tray into the desired location and determine the position, the depth and the clearance required for the waste. Ensure there is sufficient support around the waste, see separate tray instructions.

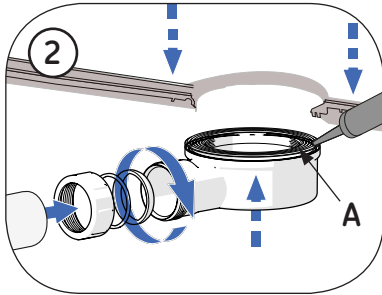

(2) Before fitting the waste, place the nut onto the waste pipe, followed by the backing ring and the seal. Insert waste pipe into the waste and tighten the nut. Check that the pipe connection is correctly assembled, sealed and watertight. Ensure that the seal (A) is positioned into the recessed section on the top of the waste body before connecting to the tray.

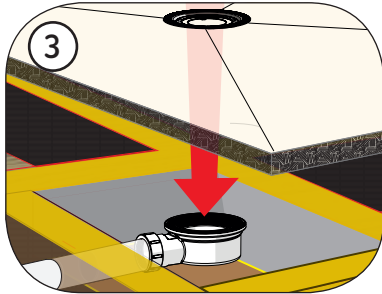

(3) Lower the tray into position over the waste.

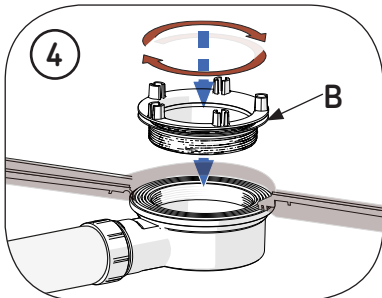

(4) Ensure the clamping ring seal (B) is fitted to the clamping ring.



(5) Screw the locking ring into the waste body on the top side of the tray. Do not over tighten.

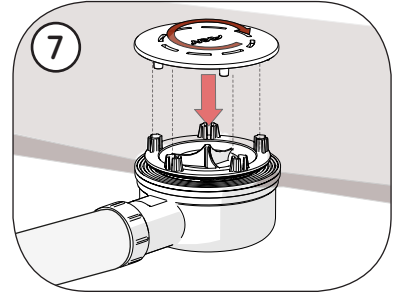
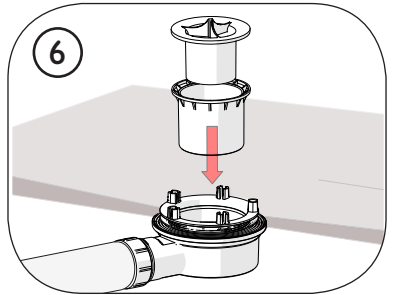
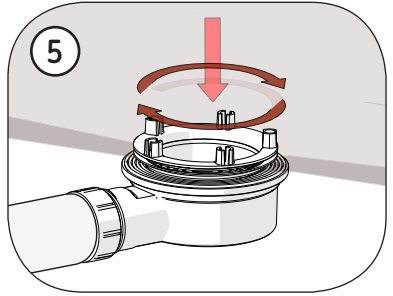

(6) Lower the trap into waste main body.

(7-8) Temporarily cover the waste to prevent debris getting into it. Only when installation is complete fit the dome cover ensuring the location pegs are inserted into the locking ring.

User Care Instructions

AKW wastes are designed for low maintenance and reliable operation. The water trap is located inside the waste body should be checked as part of a planned maintenance programme.

Keeping your wastes clean

This product should be cleaned periodically to remove any accumulation of hair or other waste material, using normal domestic bathroom cleaning materials.

To remove and clean the trap, first remove the cover to gain access to the trap.

Disinfecting

Where disinfecting is necessary, standard procedures for disinfecting equipment should be used, taking due care and attention to the warning signs concerning possible effects of aggressive chemicals on plastics.

After cleaning, always flush down with water then wipe thoroughly with a damp cloth to remove any cleaning material residues before drying.

Do not use strong or concentrated acidic, alkaline or other cleaning materials as these may discolour or otherwise damage the product. Do not use abrasive cloths.

AKW does not approve or recommend autoclave cleaning of any of the components due to the damage which this can cause to the special engineering plastics used in the construction of this product.

Packaging

Wastes are supplied in a polypropylene (PP) bag to keep the product unsoiled until installation; it may also be packed in a cardboard box. Both are suitable for recycling operations and should be disposed of in accordance with local recycling regulations.

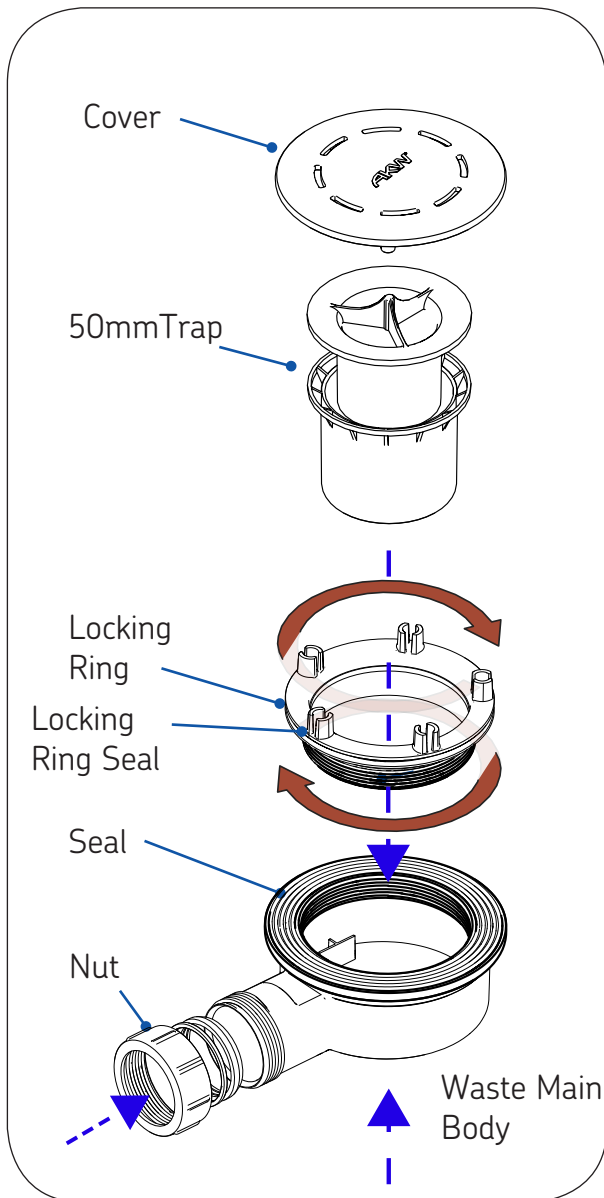



Important Safety Information

 **ALWAYS** read these installation instructions carefully before installing this product and leave with the end user for future reference.

 **ALWAYS** have the waste installed by a trained and experienced installer.

 **ALWAYS** match the correct waste to the shower tray.

 **NEVER** use the waste without the unit fully assembled.

 **Caution** always check for electric cables and water pipework before cutting into floor boards or drilling into surfaces.

 **Beware** a pinch hazard may be present around the edges during installation.

Technical Help line
01905 560219

Orderline
01905 823299

General Enquiries
01905 823298

Fax
01905 823297

Website
www.akw-ltd.co.uk

Quotes & orders email
orders@akw-ltd.co.uk

Enquiries email
sales@akw-ltd.co.uk
technicalenquiries@akw-ltd.co.uk

Post
AKW, Pointon Way,
Hampton Lovett,
Droitwich Spa,
WR9 0LR



For the latest AKW product news scan this QR code with your device.

* Guarantee



The life time guarantee only applies to manufacturing or material defects conditional on the one-time correct installation of the product and does not apply to blockages, inappropriate use or accidental damage. This does not cover damage or defects that result from incorrect installation, lack of maintenance including the build up of grime, dirt or lime-scale and water-borne debris, damage resulting from inappropriate cleaning or water ingress, damage from water freezing, damage or defects that result from repairs or modifications undertaken by unauthorised persons who are not maintenance engineers. This guarantee excludes general wear and tear through usage and does not apply to surface finishes.

What to do if something goes wrong?

In the event that you should encounter a problem with this product, please contact your local installer and if this does not resolve the issue, then contact AKW technical team who will provide further advice and, if necessary, arrange for a maintenance engineer to visit and report any issues.

As part of our quality and training program, calls may be monitored or recorded. None of the foregoing affects your statutory rights.

These instructions are provided to advise the minimum standards of installation and recommends what the best practice for the installation is. Due to the very wide variability of possible installation conditions, AKW cannot provide all circumstances for the installation. AKW cannot accept any liability in connection with this information or its use. This information is provided on the condition that the person receiving it shall make his/her own tests to determine the suitability for the particular purpose. Failure to install this AKW product in accordance with supplied instructions or the making of unauthorised modifications will invalidate any warranty and may affect product safety. None of the foregoing affects your statutory rights.