

(EN) Load bearing installation recommendations

- Pressalit can only be held responsible for installations carried out by Pressalit's own installers.
- Pressalit can not be held responsible for reinforcements made in a faulty manner.
- The below recommendations are based on experience and internal test results.
- The below recommendations are to be considered as guidelines only.
- Subject to alteration without further notice.

This advisory document shows the maximum load capacity for individual bolts and other types of anchors that can be used for fixing Pressalit's products to the wall.

The maximum load capacities shown below are per bolt/anchor and must be considered in relation to the information provided for the product that is being fitted. The information specific to the product will show how great the load is on each fixing point when the product is used at its recommended safe working load.







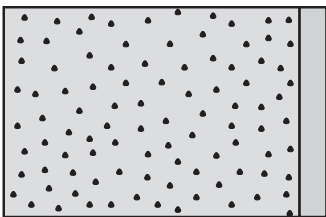

Only if the load on each fixing point of a given product is less than the maximum load capacity of the type of bolt/anchor under consideration, should the bolt/anchor in question be used.

E.g.

One might wish to fit a nursing bench 3000 to an aerated concrete wall:

Maximum load Maximum load: 200 kg.
 When the bench is loaded with 200 kg, each mounting bolt supports 26 kg.











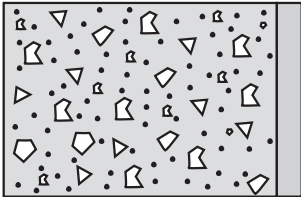





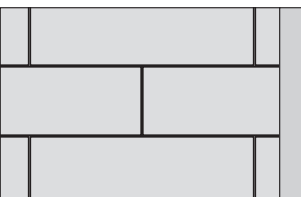





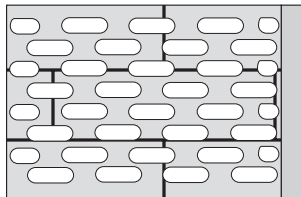



Each fixing point is here carrying a load of 26 kg, and the bolts typically recommended for aerated concrete (Ø10, M8, M10) all have a maximum load capacity that is higher than 26 kg, so they can all be used.

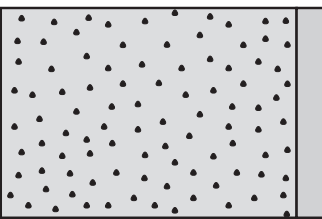









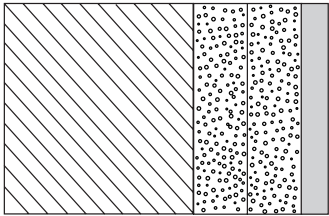

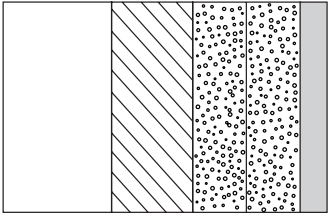

Aerated Concrete P4	Plug	Anchor / Bolt	Maximum load per anchor
	fischer GB 14 	Ø10 x 80-105 	90 kg.
	fischer FTP M 8 	M8 x 35 	65 kg.
	fischer FTP M 8 	M8 X 35 	65 kg.
	fischer FTP K 6 	M5 x 50 	40 kg.

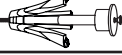
Please see the mounting instructions and the technical datasheets (both can be downloaded from our website) for information about which types of bolts/anchors are recommended for use on which type of wall.

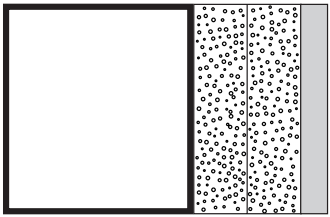
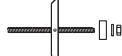
Fixing kits to be specified and ordered separately.
 They do not come included with the product.

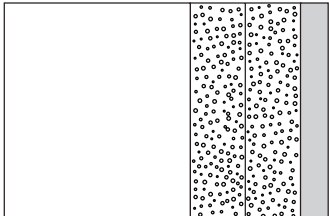
Choose the appropriate anchor for your wall

Concrete > B25	Plug	Anchor	Maximum load per anchor
	fischer SX 12 	Ø10 x 70/80 	170 kg.
	fischer SX 10 	Ø8 x 70/80 	120 kg.
	fischer SX 6 	Ø5 x 50 	65 kg.
Solid brick >= Mz12	Plug	Anchor	Maximum load per anchor
	fischer SX 12 	Ø10 x 70/80 	70 kg.
	fischer SX 10 	Ø8 x 70/80 	60 kg.
	fischer SX 6 	Ø5 x 50 	30 kg.
Solid sand lime brick >= Hz12	Plug	Anchor	Maximum load per anchor
	fischer SX 12 	Ø10 x 70/80 	170 kg.
	fischer SX 10 	Ø8 x 70/80 	120 kg.
	fischer SX 6 	Ø5 x 50 	50 kg.
Aerated Concrete P4	Plug	Anchor / Bolt	Maximum load per anchor
	fischer GB 14 	Ø10 x 80-105 	90 kg.
	fischer FTP M 8 	M8 x 35 	65 kg.
	fischer FTP M 8 	M8 X 35 	65 kg.
	fischer FTP K 6 	M5 x 50 	40 kg.

Drywall (2 X 12,5 mm) water-resistant, re-enforced with wood	Anchor	Maximum load per anchor
	Ø10 x 70/80 	120 kg.
	Ø8 x 70/80 	100 kg.
	Ø5 x 50 	40 kg.
Drywall (2 X 12,5 mm) water-resistant, re-enforced with 22 mm plywood	Anchor	Maximum load per anchor
	fischer KD8 toggle 	133 kg.
	Wingit 	133 kg.
	Snaptight 	133 kg.
Drywall (2 X 12,5 mm) water-resistant, re-enforced with steel plates (2 mm)	Anchor	Maximum load per anchor
	fischer KD8 toggle 	94 kg.
	Wingit 	94 kg.
	Snaptight 	94 kg.
Drywall (2 X 12,5 mm) water-resistant	Anchor	Maximum load per anchor
	fischer KD8 toggle 	85 kg.
	Wingit 	85 kg.
	Snaptight 	85 kg.

Reinforcement of wall with 40-50 mm wood

Reinforcements of walls should always comply with national standards.

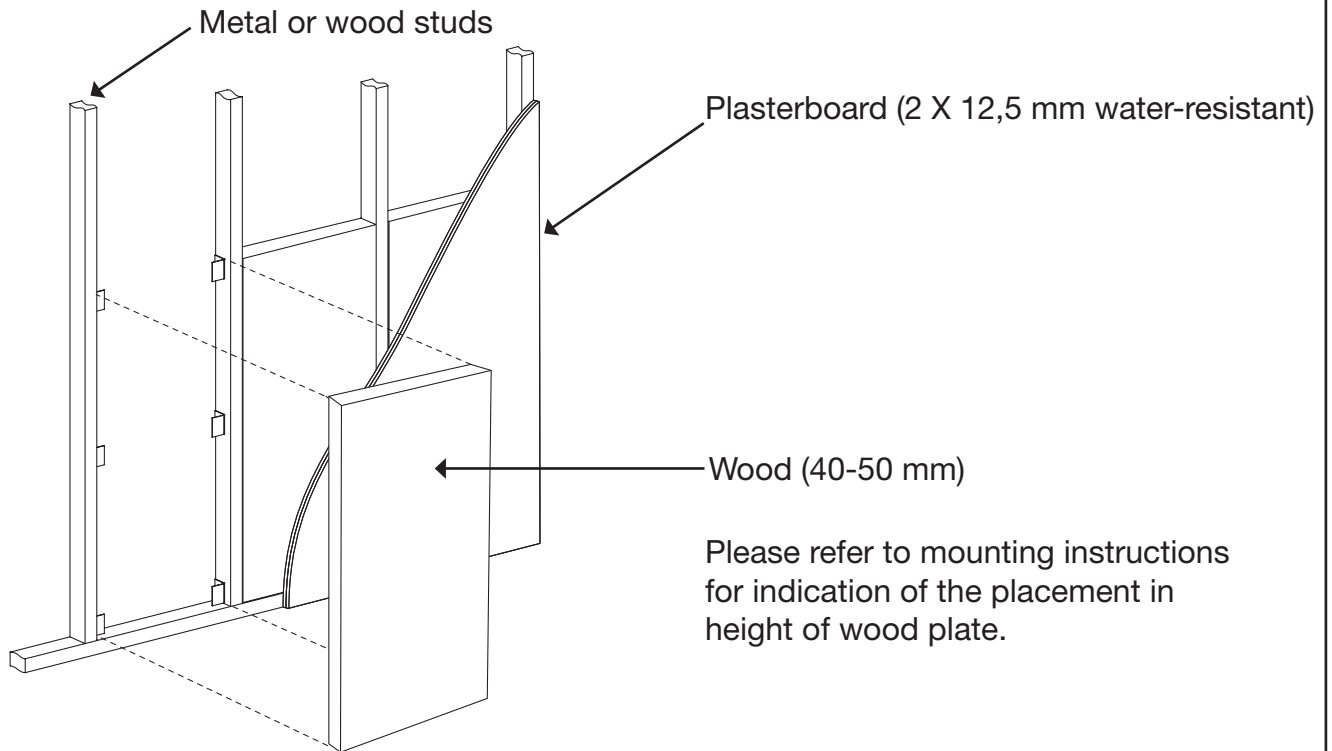

Please refer to mounting instructions for indication of the placement in height of wood plate.

Wall cross-section

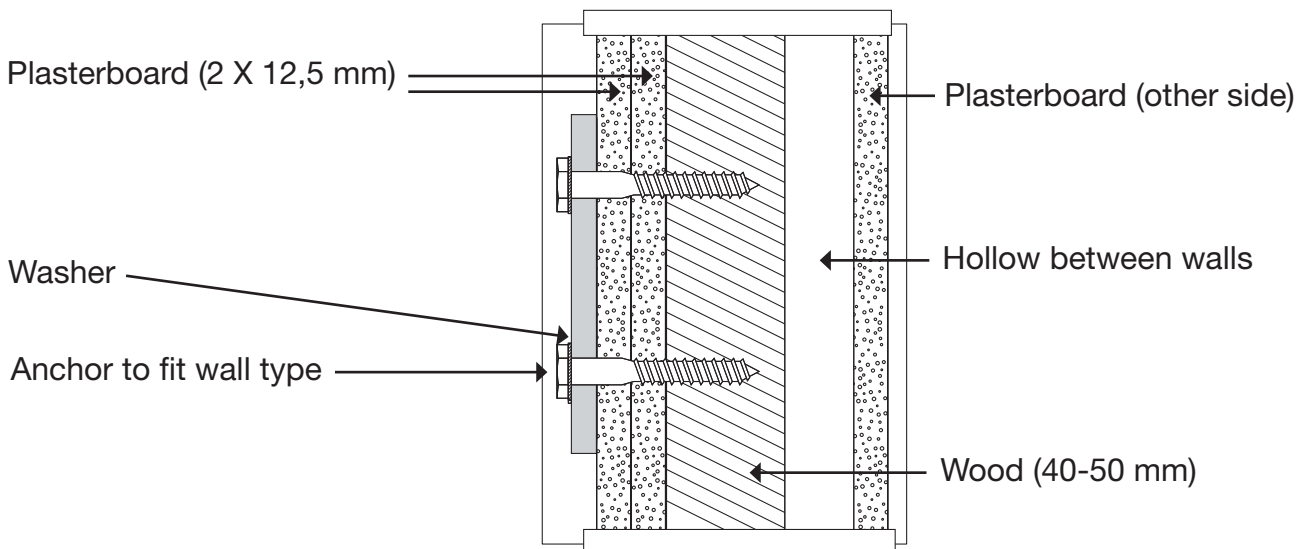

Reinforcement of wall with plywood

Reinforcements of walls should always comply with national standards.

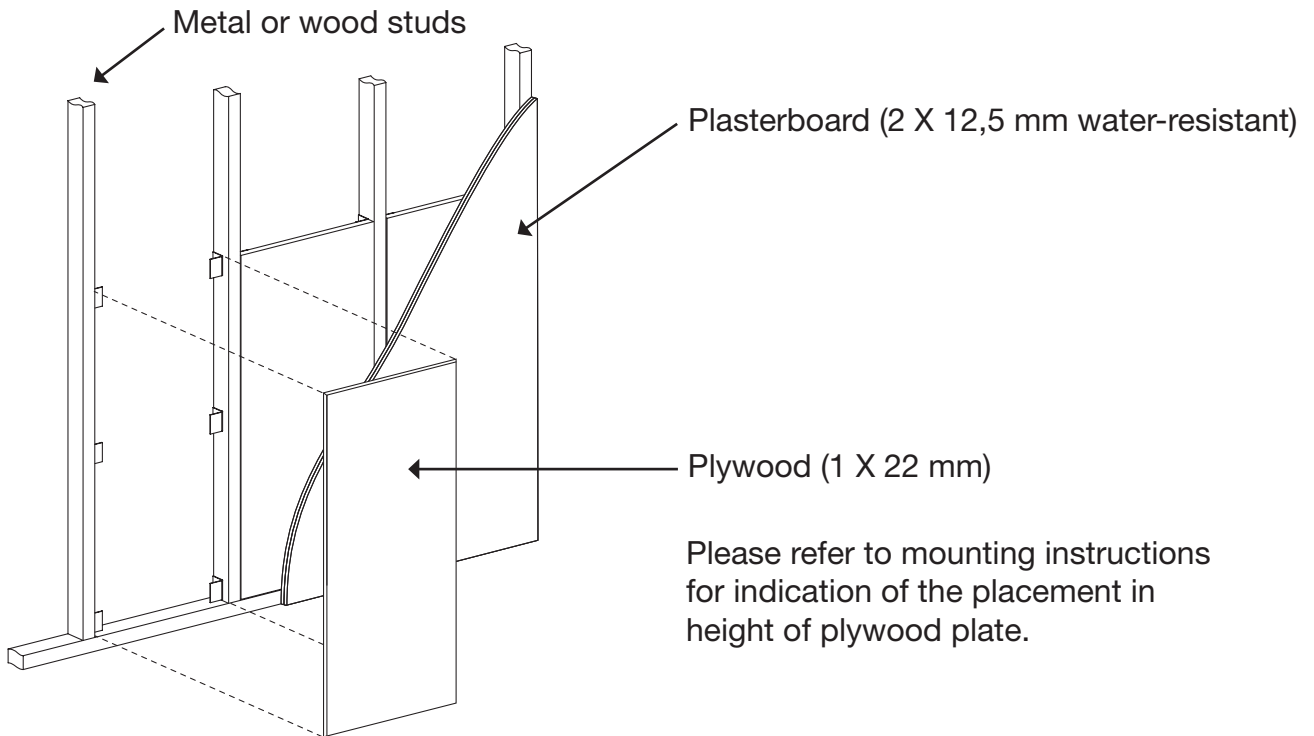

Wall cross-section

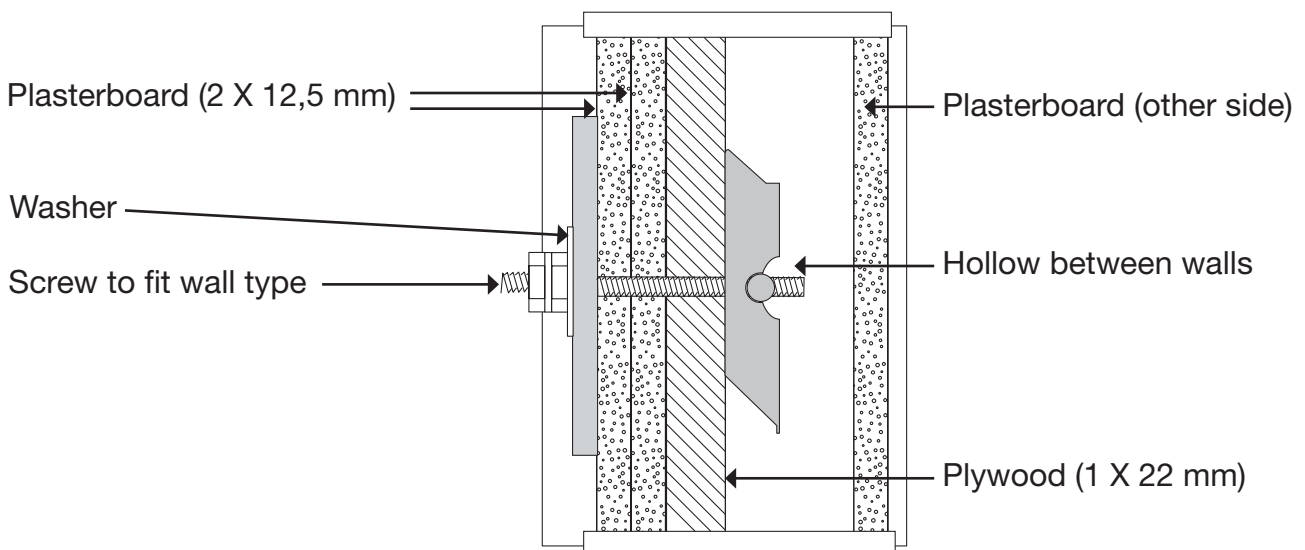

Reinforcement of wall with steel

Reinforcements of walls should always comply with national standards.

