

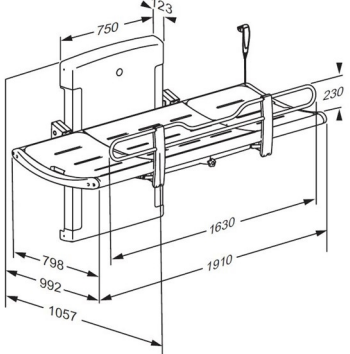

Product Item number	SCT 3000 shower change table, electrically height adjustable R8582318299
Colour Product description	<p>VVS: 777543498 EAN: 5708590374116 HMI: 130164</p> <p>Sapphire blue (RAL 5003)</p>  <p>Pressalit offers a variety of mobile and wall-hung, height-adjustable and fixed height shower and changing tables of high quality. They are designed to provide a stable platform for showering and changing adults and children with reduced mobility. These tables can be used in schools, institutions, hospitals and private homes and are all designed to be durable, comfortable and easy to clean. The design and flexibility of the tables ensures optimal working conditions for the carer as well as a high level of comfort and safety for the user.</p> <p>The SCT 3000 series has a stylish and award-winning design focused on comfort and ease of use.</p> <p>SCT 3000 shower change table, powered, height adjustable 700 mm; from 300 mm - 1000 mm, with wired hand control Foldable. Incl. safety rail and water collection tray with integrated outlet. Surface length 1800 mm, outer measurements 1057 mm x 1910 mm. Materials: Powder-lacquered stainless steel, aluminium, polyurethane foam and polystyrene. Excl. mounting kit.</p>
Adjustability Adjustment height Product capacity Speed Noise level	<p>Height adjustable</p> <p>700 mm</p> <p>Maximum load: 200 kg. When the table is loaded with 200 kg, each mounting bolt supports 26 kg <i>This product has been tested statically with a load of 500 kg as the IEC 60601-standard requires testing with safety factor 2.5.</i></p> <p>Speed up mm: 15 mm/s Speed down mm: 20 mm/s</p> <p>48 dB</p>





Product	SCT 3000 shower change table, electrically height adjustable
Item number	R8582318299
Materials	Aluminium, polyurethane foam, plastics, powder-laquered steel.
Ergonomy	<ul style="list-style-type: none">• The ergonomically designed safety rails have a practical lower central section, which provides better access and work environment for the carer while transferring, showering, drying, changing and dressing the user.• One hand operated safety rails allows the carer to maintain eye contact as well as physical contact with the user during the whole process.• Easy to clean, smooth contact surfaces which do not collect dirt and bacteria.
Features	<ul style="list-style-type: none">• A water collection tray with integrated water outlet prevents water from splashing on carers or the floor. The flexible hose attached to the center mounted outlet of the water collection tray, can be connected to either an outlet in the floor or on the wall.• The slightly curved shape makes the table comfortable and safe to lie on.• Adjustable neck support which can be moved to either end of the 1800 mm shower and changing tables.• The integrated gas cylinders enable the table to be folded out of the way when not in use to maximize floor space.• The powered shower change table is supplied with a wired hand control. The red buttons clearly indicate "up" and "down".• The wired hand control comes with a practical holder for placement on the wall.
Mains connection (V)	230
Actuator (motor)	LA40CS Careline (Linak) 4000 N, IPX6
Control box	SMPS14 Careline (Linak), IPX6
Wired remote control	HB3 (Linak), IPX6
Power consumption (maximum load)	Power consumption by maximum load, watt: 144 W Power consumption by standby: 2 W







Product	SCT 3000 shower change table, electrically height adjustable
Item number	R8582318299
Warranty	Pressalit makes a commitment to remedy material and manufacturing defects for a period of three years from the invoicing date. NOTICE If the product is installed in an atmosphere heavy in salt or chloride, the warranty will be reduced from the normal 3 years to 1 year. Salt and chloride have a corrosive effect on the products components and will cause a decrease in the life expectancy of the product. The damaging effects can, however, be reduced if the product is showered with tap water on a daily basis.
Cleaning	<p>SCT 3000.</p> <p>The product is to be cleaned with hot water or a mild soapy cleaning agent. Do not use chlorine based, corrosive or abrasive cleaners as it may result in the surface being damaged.</p> <p>The following cleaning agents have been tested by Pressalit and may be used, as long as they are diluted according to the instructions on the container.</p> <p>DISINFECTANTS: Clinimax Difficil-S Erisan OXY+ Clinell Universal Wipes Clinel Sporidical Wipes Chlor-Clean Tablets WipeClean Ethanol Disinfection 80% Wetwipe Ethanol Disinfection 70% (wetwipe)</p> <p>NON-DISINFECTANTS: Wetwipe Universal</p> <p>The product must be wiped down with a soft rag wrung out in clear water immediately after cleaning, as some materials may otherwise be discolored and stained, and the surface coating may deteriorate.</p> <p>DECALCIFICATION OF ALUMINUM PARTS: Pressalit recommends that chalky deposits be removed from wall tracks and other aluminum parts using a solution of three parts 30% acetic acid to seven parts tap water. When the aluminum parts have been washed down with this solution, the parts must be wiped over with a damp cloth wrung out in clear water.</p>
WEEE	Please enquire of your local Pressalit subsidiary or distributor (in countries where there is no subsidiary) that will arrange for recycling of electronic waste in accordance with the WEEE directive.
Declaration of conformity	This product is in compliance with all relevant requirements of regulation (EU) 2017/745 on medical devices. It also complies with all relevant requirements in the Council Directive 2006/42/EC (of 17 May 2006) on machinery and the Council Directive 2011/65/EC on RoHS.





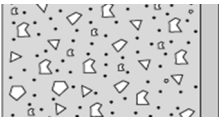
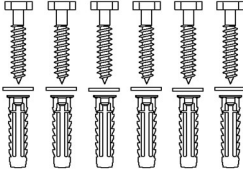

Product	SCT 3000 shower change table, electrically height adjustable
Item number	R8582318299

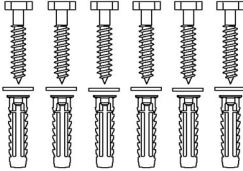
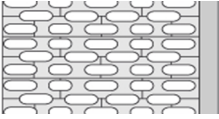
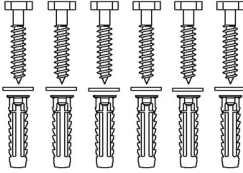
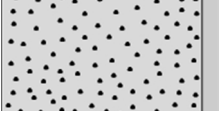
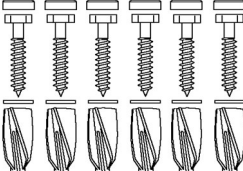
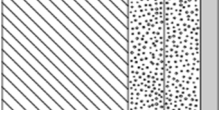
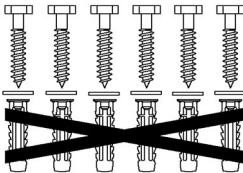
Installation in different wall types

	<p>Concrete >B25</p> <p>V8608 - Mounting kit, 6 coach screws Ø10 x 70 - plugs SX12. To be ordered separately.</p>	
	<p>Solid Brick >= Mz12</p> <p>V8608 - Mounting kit, 6 coach screws Ø10 x 70 - plugs SX12. To be ordered separately.</p>	
	<p>Solid Sand Lime Brick >= Hlz12</p> <p>V8608 - Mounting kit, 6 coach screws Ø10 x 70 - plugs SX12. To be ordered separately.</p>	
	<p>Aerated Concrete P4</p> <p>V8658 - Mounting kit, 6 coach screws Ø10 x 70 - plugs GB14. To be ordered separately.</p>	
	<p>Drywall (2 x 12,5 mm) water-resistant, re-enforced with wood</p> <p>V8608 - Mounting kit, 6 coach screws Ø10 x 70 - plugs SX12. NB! Plugs are not needed. To be ordered separately.</p>	



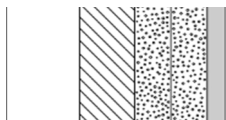
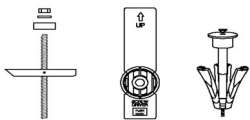
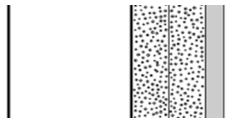
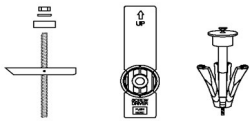
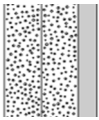

Product Item number	SCT 3000 shower change table, electrically height adjustable R8582318299
	Drywall (2 x 12,5 mm) water-resistant, re-enforced with 22 mm plywood Wall fasteners (6 pcs) must be bought separately, for drywall it is possible to use e.g. fischer KD8 toggles or similar. 
	Drywall (2 x 12,5 mm) water-resistant, re-enforced with steel plates (2 mm) Wall fasteners (6 pcs) must be bought separately, for drywall it is possible to use e.g. fischer KD8 toggles or similar. 
	Drywall (2 x 12,5 mm) water-resistant Mounting in this wall type is not recommended - risk of fatal injury to persons and walls. 

It is the responsibility of the installer to ensure that suitable wall fasteners are used.

