



Independent 4 Life

Purus Living Plus 700mm Linear Drain, Vinyl Floor, SS Grate - Outlet Choice

£484.67 Inc. VAT

Product Code: 53309-11

Product Images

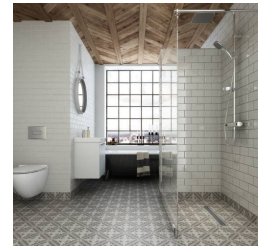

Waste Options:

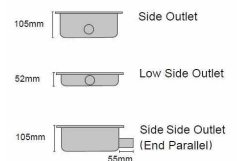

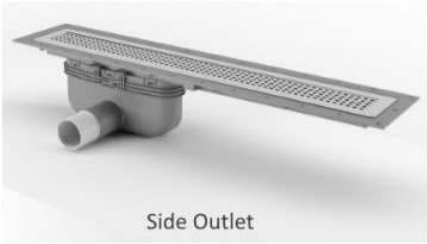

Side Outlet

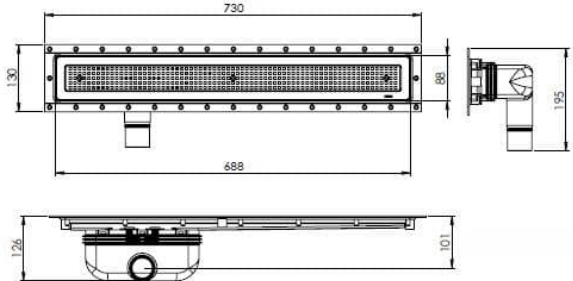

Low Side Outlet

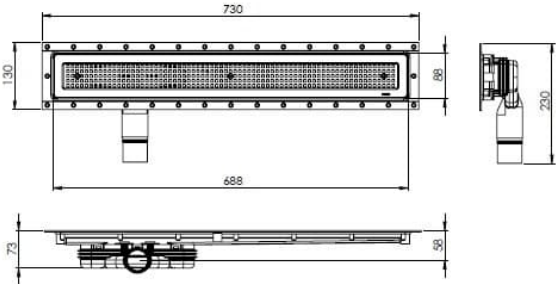

Side Side (Parallel) Outlet

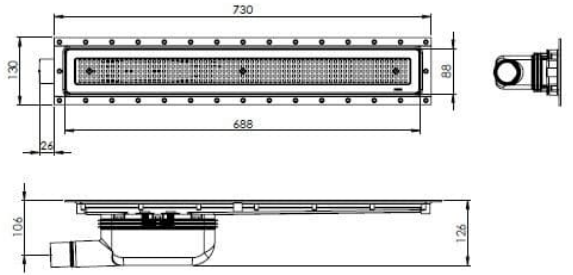

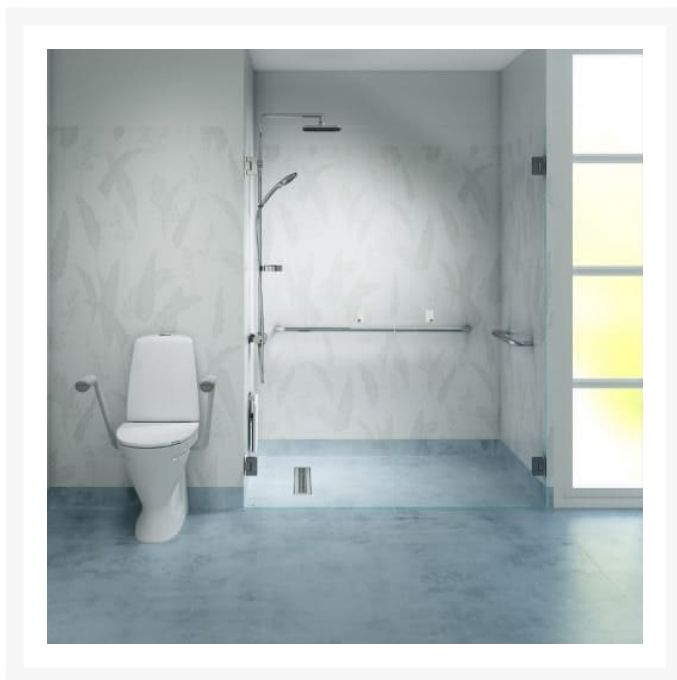
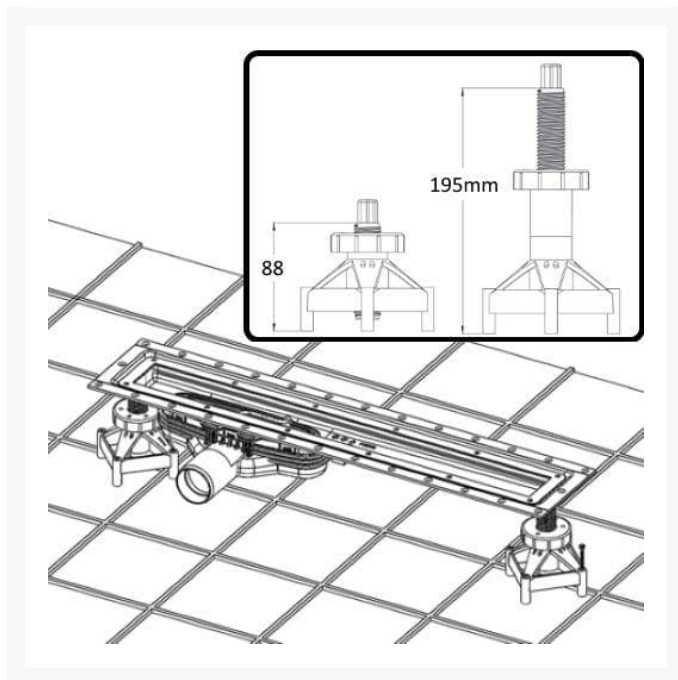

Product Options

Waste Outlet / Depth (mm)	Price Inc. VAT
Horizontal - 52mm Low Side	£484.67
Horizontal - 105mm Side	£484.67
Horizontal - 105mm Side Side (End Parallel)	£484.67

Description

Purus 730mm Living Plus linear channel drain for wet rooms with vinyl sheet flooring with a maximum thickness of 3mm.

Designed for use with concrete / screed floors only. For timber floors use the 600 or 800mm Purus Living Plus Linear Drains.

Key benefits:

- 730mm length linear channel drain
- PP - bodied unit
- Removable sprung NOOD water trap
- The NOOD no-odour water trap which will not allow any foul air to escape even if the gully dries out
- Removable stainless steel channel grate - Chess design
- The grate when installed will be flush with the vinyl sheet flooring, due to the new clamping ring technology
- For vinyl sheet floor finishes, that should be secured in the gully clamping frame

- Includes 2 x support legs for screed floors

Technical details:

- Overall length (mm): 730
- Overall width (mm): 130
- Grate length (mm): 688
- Grate width (mm): 88
- Depth of channel (mm): 21, (plus depth of gully outlet - see below)
- Grate loading: Class K 3 (300 kg)
- Maximum vinyl sheet flooring thickness (mm) 3

Waste options:

- Choice of three NOOD water trap outlets each with a push-fit ABS pipe reducer 2" to 1½" (50mm to 40mm):
- Product Code: 53309 - Side Outlet with 60-72 Ltr/min flow rate - Waste depth / Overall (mm): 105 / 126
- Product Code: 53310 - Low Side Outlet with 30-36 Ltr/min flow rate - Waste depth / Overall (mm): 52 / 73
- Product Code: 53311 - Side Side (End Parallel) Outlet with 60-72 Ltr/min flow rate - Waste depth / Overall (mm): 105 / 126
- Please select as desired

Installation Guidance:

- The minimum gradient should be 1:150 to ensure the flow of water to the floor trap and no more than 1:50 to reduce the risk of slipping
- A nominal 2% falls is usually used
- Do not install the product on a raised platform. It is designed only to be installed level with the surrounding floor

Concrete / Screed Floor Installation:

- Build falls to the gully with screed so water can run into it
- Supplied with 2 x plastic concrete supports, for setting the gulley height and level prior to casting the concrete screed
- The Concrete supports have a min. height of 88mm and a max height of 195mm with a distance case at 50mm
- Refer to the PDF download installation instructions for more information

Warranty:

- The design life of the Purusline Living Plus is 25 years, as long as they are installed and used following the installation and maintenance instructions and only in use with normal shower water.

Additional Information

Manufacturer	Purus
Configuration	700mm Linear Drain
Installation	Floor Formers, Concrete / Screed Floors, Timber Floors
Application	Screed Floors
Waste Depth / Outlet Position	105mm / Side, 52mm / Low Side, 105mm / Side Side (End Parallel)
Flow Rate / l/min	30-36, 60-72
Floor Finish	Vinyl Sheet Flooring
Grate Material / Finish	Stainless Steel / Chess Grid