



Independent 4 Life

HEWI System 900 - 700mm Hinged Support Rail Duo Design A, OPT Leg - Choice of Finish

From: £457.08
To: £1,017.48
Inc. VAT

Product Code: 900.50.102

Product Images

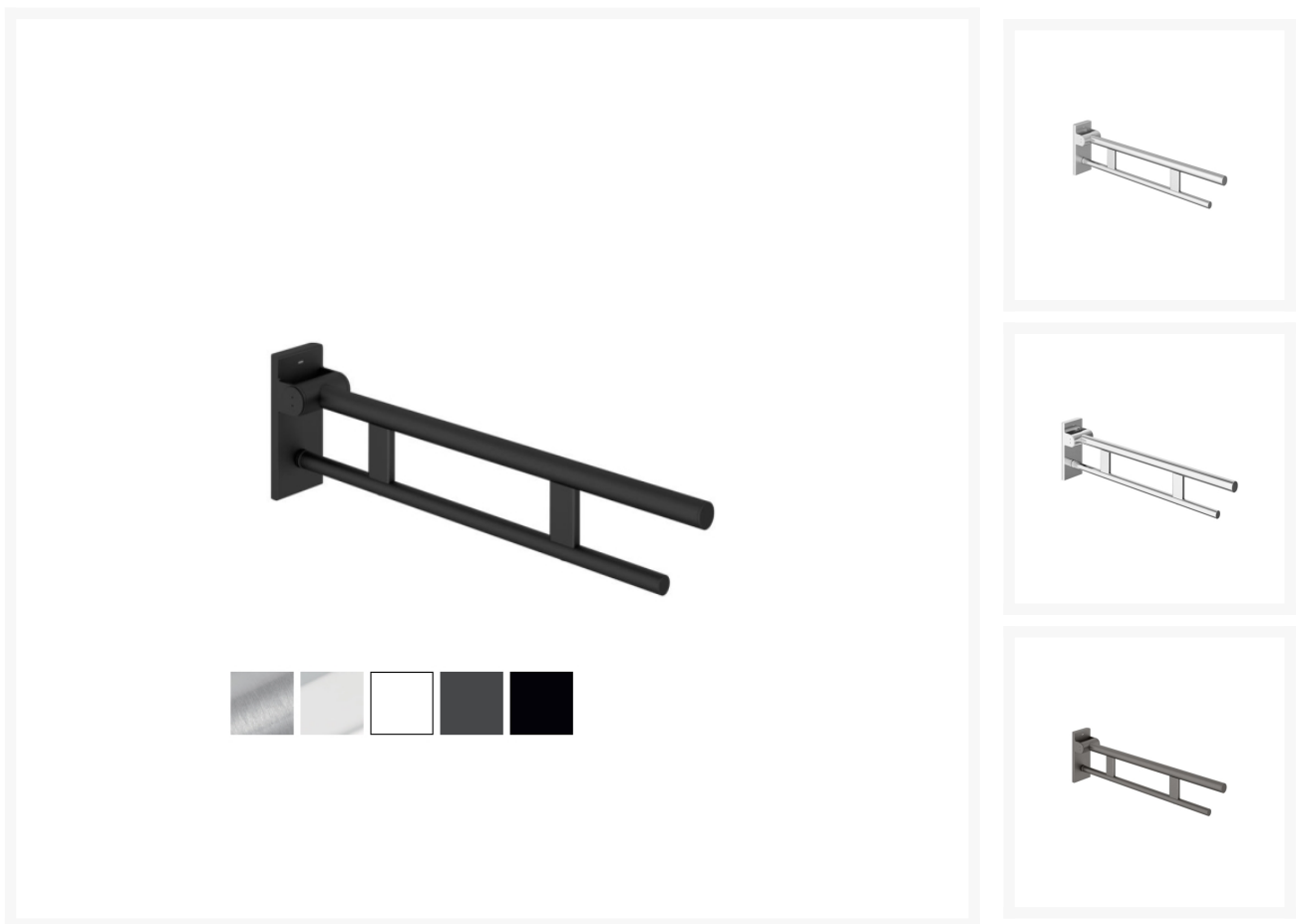

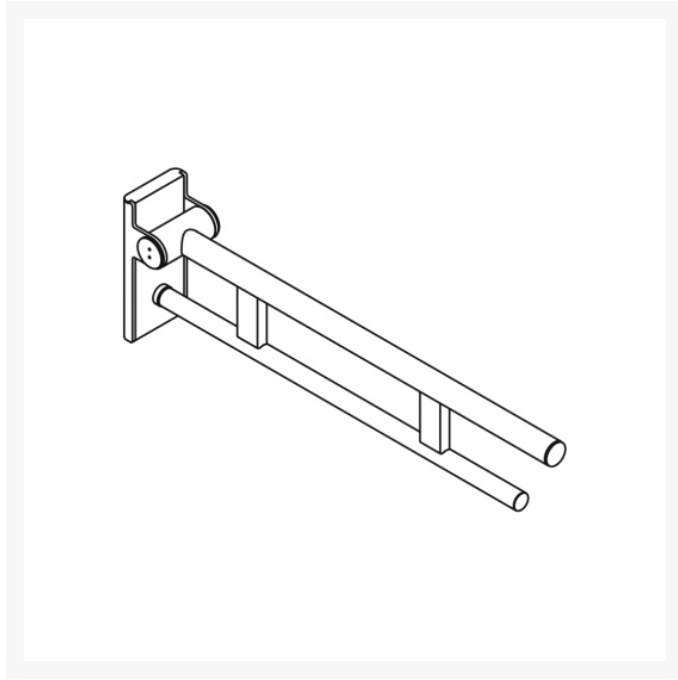
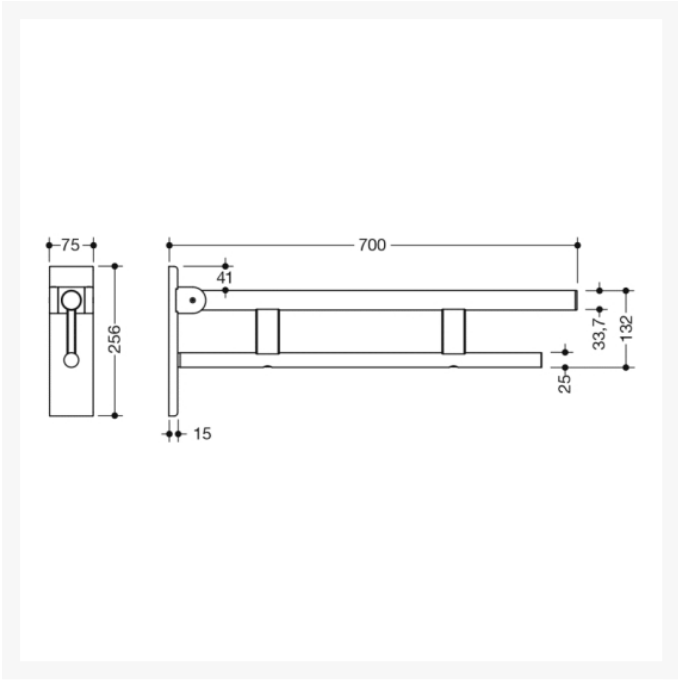
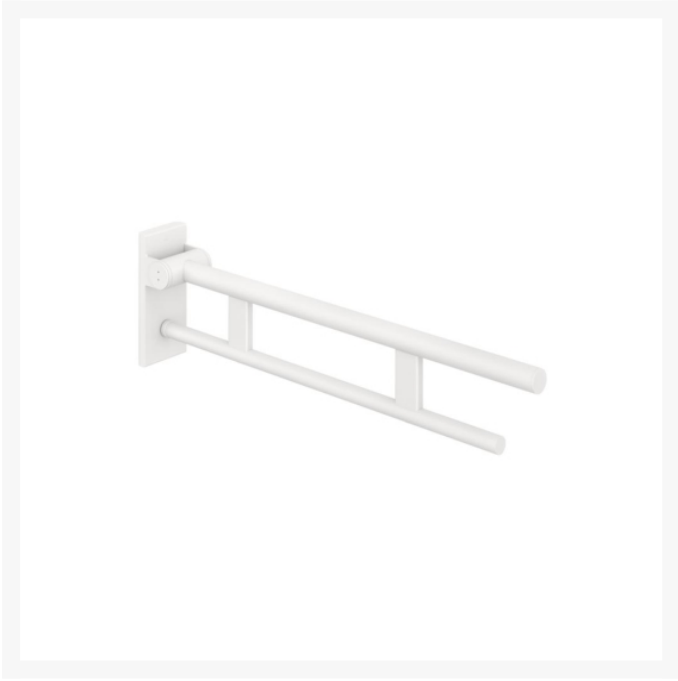

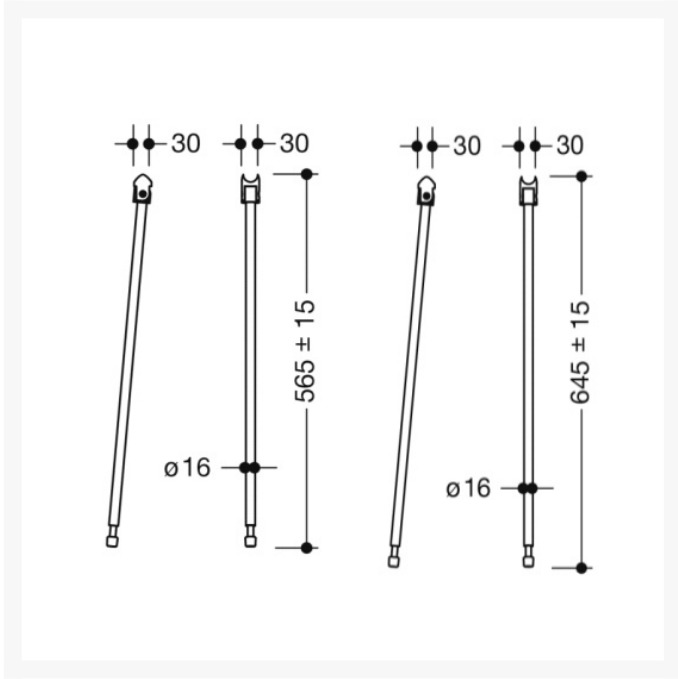









Product Options



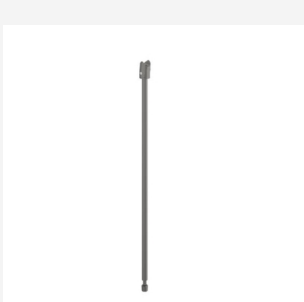

Product Code / Finish / Length (mm)

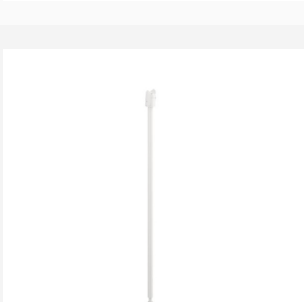
	<p>900.50.102XA - 700mm Hinged Support Rail Duo Design A - Satin Finish</p> <p>HEWI Hinged Support rail Duo Design A, is easily accessible for all, stylish Matt Black finish, made of stainless steel. Smooth and easy moving joint, 256mm high and 75mm wide with a loading capacity of 100kg.</p>	£380.90
	<p>900.50.10240 - 700mm Hinged Support Rail Duo Design A - Chrome Plated</p> <p>HEWI Hinged Support rail Duo Design A, is easily accessible for all, stylish Chrome Plated finish, made of stainless steel. Smooth and easy moving joint, 256mm high and 75mm wide with a loading capacity of 100kg.</p>	£547.90
	<p>900.50.10260DX - 700mm Hinged Support Rail Duo Design A - Powder Coated Matt White</p> <p>Hewi Hinged Support rail Duo Design A, is easily accessible for all, stylish Matt White finish, made of stainless steel. Smooth and easy moving joint, 256mm high and 75mm wide with a loading capacity of 100kg.</p>	£523.80
	<p>900.50.10260SC - 700mm Hinged Support Rail Duo Design A - Powder Coated Matt Dark Grey Pearl Mica</p> <p>HEWI Hinged Support rail Duo Design A, is easily accessible for all, stylish Powder Coated Matt Dark Grey Pearl Mica finish, made of stainless steel. 256mm high and 75mm wide with a loading capacity of 100kg.</p>	£523.80
	<p>900.50.10260DC - 700mm Hinged Support Rail Duo Design A - Matt Black</p> <p>HEWI Hinged Support rail Duo Design A is easily accessible for all, stylish Matt Black finish, made of stainless steel. Smooth and easy moving joint, 256mm high and 75mm wide with a loading capacity of 100kg.</p>	£523.80

Optional Support Leg 565mm

	<p>900.50.021XA - 565mm Length - Satin Finished</p> <p>HEWI Floor Support, for retrofitting on hinged support rails, creating a steady anchor for all ages and abilities to be able to use. In a stylish satin finish. Made of high quality stainless steel. With a vertical length of 565mm and a mounting height of 680mm.</p>	£97.90
	<p>900.50.02140 - 565mm Length - Chrome Plated</p> <p>HEWI Floor Support, for retrofitting on hinged support rails, creating a steady anchor for all ages and abilities to be able to use. In a stylish chrome plated finish. Made of high quality stainless steel. With a vertical length of 565mm and a mounting height of 680mm.</p>	£150.00
	<p>900.50.02160SC - 565mm Length - Matt Dark Grey Pearl Mica</p> <p>HEWI Floor Support, for retrofitting on hinged support rails, creating a steady anchor for all ages and abilities to be able to use. In a stylish powder coated matt dark grey pearl mica. Made of high quality stainless steel. With a vertical length of 565mm and a mounting height of 680mm.</p>	£143.30
	<p>900.50.02160DC - 565mm Length - Matt Black</p> <p>HEWI Floor Support, for retrofitting on hinged support rails, creating a steady anchor for all ages and abilities to be able to use. In a stylish powder coated matt black finish. Made of high quality stainless steel. With a vertical length of 565mm and a mounting height of 680mm.</p>	£143.30
	<p>900.50.02160DX - 565mm Length - Matt White</p> <p>HEWI Floor Support, for retrofitting on hinged support rails, creating a steady anchor for all ages and abilities to be able to use. In a stylish powder coated matt white finish. Made of high quality stainless steel. With a vertical length of 565mm and a mounting height of 680mm.</p>	£143.30

Optional Support Leg 645mm

	<p>900.50.020XA - 645mm Length - Satin Finished</p> <p>HEWI Floor Support, for retrofitting on hinged support rails, creating a steady anchor for all ages and abilities to be able to use. In a stylish satin finish. Made of high quality stainless steel. With a vertical length of 645mm and a mounting height of 760mm.</p>	£97.90
	<p>900.50.02040 - 645mm Length - Chrome Plated</p> <p>HEWI Floor Support, for retrofitting on hinged support rails, in a stylish chrome plated finish. Made of high quality stainless steel. With a vertical length of 645mm and a mounting height of 760mm.</p>	£150.00
	<p>900.50.02060SC - 645mm Length - Matt Dark Grey Pearl Mica</p> <p>HEWI Floor Support, for retrofitting on hinged support rails, creating a steady anchor for all ages and abilities to be able to use. In a stylish matt dark grey pearl mica finish. Made of high quality stainless steel. With a vertical length of 645mm and a mounting height of 760mm.</p>	£143.30
	<p>900.50.02060DC - 645mm Length - Matt Black</p> <p>HEWI Floor Support, for retrofitting on hinged support rails, creating a steady anchor for all ages and abilities to be able to use. In a stylish matt black finish. Made of high quality stainless steel. With a vertical length of 645mm and a mounting height of 760mm.</p>	£143.30
	<p>900.50.02060DX - 645mm Length - Matt White</p> <p>HEWI Floor Support, for retrofitting on hinged support rails, creating a steady anchor for all ages and abilities to be able to use. In a stylish powder coated matt white finish. Made of high quality stainless steel. With a vertical length of 645mm and a mounting height of 760mm.</p>	£143.30

Description

The HEWI, Duo Design A Hinged support rail, with two parallel round gripping levels arranged on top of each other, made of quality stainless steel. Folding support arm with a friction hinge, and 700mm projection. Fixings are concealed, creating a modern appearance. Permanently smooth and easy moving joint. With a choice of five stylish finishes.

Optional colour matching HEWI floor supports legs, are also available in two lengths 565 and 645mm, for retrofitting onto the rails to increase stability when the support rail is in use.

Using the System 900 you can create a stylish and flexible handrail installation.

Key benefits:

- Suitable for both wet and dry environments
- Friction hinge for assisted use
- Folding rail
- Easy installation
- Pore-free surfaces
- Doc M compliant
- **Choice of five finishes / Product Code:**
- - Matt Black / 900.50.10260DC
- - Powder Coated Matt White / 900.50.102DX
- - Satin Finished / 900.50.102XA
- - Chrome Plated / 900.50.10240
- - Matt Dark Grey Pearl Mica / 900.50.10260SC

Technical details:

- Top rail 33.7mm diameter
- Load tested to 100kg (220lb)
- Bottom rail 25mm diameter
- 700mm length
- 210mm high and 101mm wide
- Secured by fixing screw to prevent unintentional removal

Optional Floor Support:

- Two length options: 565mm or 645mm
- Choice of five matching finishes to support rails
- Diameter of 16mm
- Height adjustment within +/- 15mm range

Warranty:

- 1 year manufacturer warranty

Please note:

- The fixing screws/bolts/wall plugs that are not included - the installer should select the correct HEWI System 900 - fixing based on wall type
- Please refer to the installation instructions for more information

Additional Information

Manufacturer	HEWI
Length (mm)	700
WC Projection (mm)	540/550, 600
Surface Finish	Powder Coated, Satin Finished, Matt White, Matt Black, Chrome Plated
Type	Hinged Arm Support
Material	Stainless Steel
Mounting	Wall
Arm Control	Friction Hinge
Fixings	Concealed
Adjustable	Fixed Height (No Adjustment)