



Independent 4 Life

10x Nymas PRO 600mm Straight Fluted ABS Grabrail - Electric Blue

£126.00 Inc. VAT

Product Code: 03F600B

Product Images

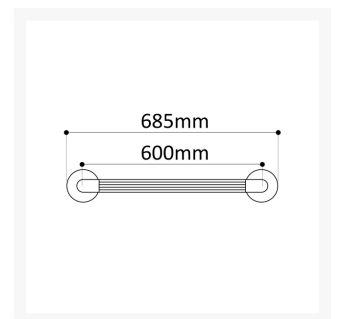

Description

Nymas Pro electric blue straight fluted handrail with a centre to centre length of 600mm and overall length of 685mm.

Fluted grabrails are ideal for domestic or commercial installations offering users a reassuring grip in and around the toilet and shower area.

Key benefits:

- Offers the user a reassuring grip in and around the shower and toilet area
- 600mm centre to centre length with 2x flanges for wall fixing
- Made from strong 36mm diameter ABS tubing
- Concealed flange plate for wall fixing and a secure installation
- 7x fixing holes on each flange plate for easy fitting, 5x or more are recommended for safe installation
- Electric Blue in colour, ideal for visual impairments

Technical details:

- Centre to centre length (mm): 600
- Total length (mm): 685
- Rail diameter (mm): 36
- ABS tubing and cover plates

Warranty:

- 2 year manufacturer warranty

Please note:

- The fixing holes require Size 6 screws (not included) the installer should select the correct fixing based on wall type

Additional Information

Manufacturer	NYMAS
Length (mm)	600
Colour	Electric Blue (RAL 5002)
Surface Finish	Ribbed Plastic
Type	Straight Grab Rail
Material	ABS Plastic
Mounting	Wall
Fixings	Concealed